

Model

Programming button Q/S
Program and delete
FUNCTION transmitters

Acknowledge button Quit
Acknowledge a call

red LED
lights up: call received
flashes: battery undervoltage

Cable entry with cord grip

Programming button R
Program and delete
CALL transmitters

Function button
Activate/deactivate functions

green LED
lights up: RCL07 ready for operation
flashes: CARE function active
off: MUTE function active or RCL07 without power supply

RCL07E5002C30

Technical details

Frequency:	868.30 MHz
Modulation:	FSK
Coding:	Easywave
Power supply:	12-24 VAC 12-32 VDC
Max. current consumption:	10 mA / 45 mA Load*
Output:	2 potential-free relay contacts (1 CO and 1 NO)
Max. contact rating AC (Ω)	
max. switching voltage:	120 VAC
max. switching current:	1 A
max. switching power:	62 W
Max. contact rating DC	
max. switching voltage:	50 VDC
max. switching current:	1 A
max. switching power:	30 W
Operating temperature:	-20 °C to +60 °C
Degree of protection:	IP54
Dimensions (w/h/h):	35/80/20 mm
Weight:	38.0 g
Connecting cable:	Ø5 mm

*) Both relays are switched.

Scope of delivery

Call receiver RCL07, operating instructions

Intended use

The device may only be operated with safety extra low voltage (SELV) and may only be used as a radio control for switching devices with safety extra low voltage (SELV). All information on the maximum contact load refers to resistive loads. If an inductive load (e.g. motor) is connected, the maximum contact load is reduced depending on cos φ. The manufacturer shall not be liable for any damage caused by improper or non-intended use.

Safety advice

- Before using the device, carefully read through the operating instructions!
- Observe the permissible supply voltage and the maximum contact load of the switching outputs! The specified maximum values for switching voltage, switching current and switching power must not be exceeded!
- Have faulty radio controls checked by the manufacturer!
- Do not make any unauthorized alterations or modifications to the receiver!

Functions

The RCL07 call receiver has two channels. Channel 1 (CH1) is used for signalling incoming calls. If the RCL07 receives an undervoltage telegram, channel 2 (CH2) switches for one second. The following applications can be realized with this:

CALL Function

When the RCL07 receives the telegram from a CALL or PRIORITY transmitter, channel 1 (CH1) switches according to the operating mode selected.

A maximum of 32 transmission codes for CALL and PRIORITY transmitters can be programmed. Programming is carried out using the internal programming button **R** (see page 2).

Each transmitter can be assigned to one of the following operating modes:

ON 1-button operation

If a transmitter button **A/B/C/D** is pressed, the relay **CH1** switches permanently **ON**.

The relay CH1 can only be switched off, by acknowledging the call.

PULSE 1-button operation

If a transmitter button **A/B/C/D** is pressed, the relay **CH1** switches for one second.

If an already programmed transmitter is programmed again, the previous operating mode will be overwritten with the currently selected one.

ACKNOWLEDGE Function

When the ACKNOWLEDGEMENT function is activated, incoming calls are additionally signalled by the red **QUIT** LED.

Acknowledgement is done using the **QUIT** button or an ACKNOWLEDGEMENT transmitter. This resets the **QUIT** LED and the **CH1** relay.

A maximum of eight ACKNOWLEDGEMENT transmitters can be programmed. The programming is done using the internal programming button **Q/S** (see page 2).

The function can be set with jumper J2:

activated: J2 Pos. 4

deactivated: J2 Pos. 3+4

If the ACKNOWLEDGEMENT function is deactivated, no CALL display is shown and the QUIT button has no function. The relay CH1 can only be reset by ACKNOWLEDGEMENT transmitters.

The ACKNOWLEDGEMENT function is activated by default.

CARE Function

If the CARE function is active, all calls will be ignored for 15 minutes.

After these 15 minutes, the CARE function is deactivated automatically, but can also be deactivated manually at any time.

The CARE function is activated or deactivated with a separate CARE transmitter or on the device using the button.

activate (green LED flashes):

Button code **B** or **D** of a CARE transmitter or Function button (>1.6s but <10s)

deactivate (green LED lights up/off):

Button code **A** or **C** of a CARE transmitter or Function button <5s

While the CARE function is active, the green LED flashes.

A maximum of eight CARE transmitters can be programmed. Programming is done using the internal programming button **Q/S** (page 2 "Programming FUNCTION transmitters").

MUTE function

The MUTE function allows unlimited muting of CALL transmitters.

As soon as the MUTE function is active, only calls from programmed PRIORITY transmitters are accepted. (page 2 'Programming PRIORITY transmitters'). Calls from normal CALL transmitters are ignored.

The RCL07 can be muted either on the device itself or with a MUTE transmitter (page 2 'Programming FUNCTION transmitters'):

MUTE the RCL07 (green LED off):

Button code **B** or **D** of a MUTE transmitter or Function button > 10s

Un-MUTE the RCL07 (green LED lights up):

Button code **A** or **C** of a MUTE transmitter or Function button > 5s

When the MUTE function is active, the green LED is off. It is not possible to check the supply voltage in this state. The CARE function is signalled nonetheless, while the RCL07 is muted.

After a power interruption, the RCL07 is always un-muted.

To be able to use the MUTE function, it must first be enabled with jumper J1:

disabled: J1 Pos. 1

enabled: J1 Pos. 1-2

The MUTE function is disabled by default.

SETTING UP THE RECEIVER

Ensure that the radio connection is unobstructed. Avoid installation in a distribution box, in enclosures made of metal, in the immediate vicinity of large metal objects, on or close to the floor.

1. Loosen the two screws on the back and open the enclosure.
2. Activate or deactivate the desired functions with the jumpers J1 and J2.
3. Connect the supply voltage and the safety extra-low voltage consumers to be switched. The polarity of the supply voltage V_{IN} does not need to be observed.
4. Transfer the coding of the transmitters to the receiver (page 2 'Programming').
5. Screw the enclosure back together.

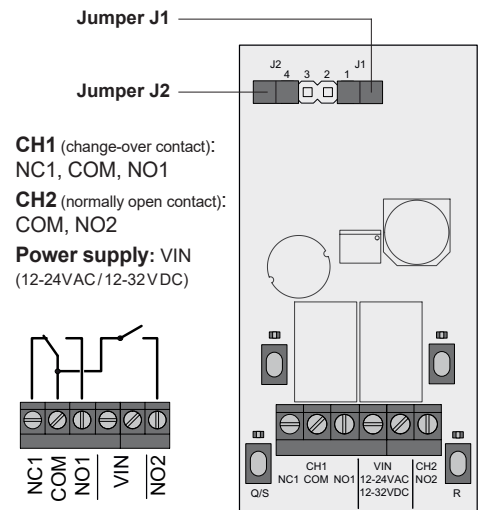

PROGRAMMING

PROGRAM TRANSMITTERS

The RCL07 only responds to previously programmed Easywave transmitters.

To program a transmitter, put the RCL07 into the programming mode for the desired operating mode or function and press the transmitter button to be programmed within 30 seconds.

If the LED flickers for 4 seconds during the programming process, the memory for the respective function is full.

If a CALL or PRIORITY transmitter that has already been programmed is programmed again, the previous operating mode is overwritten with the newly selected one. The same applies to FUNCTION transmitters.

It is not possible to overwrite a programmed FUNCTION transmitter with a CALL function and vice versa. To do this, the respective transmitter

button must first be deleted and then programmed again.

For transmitters with multiple buttons, the individual buttons can be divided between CALL and FUNCTION transmitters as desired.

When the program or delete mode is started, any pending calls are automatically acknowledged and the CH1 relay is reset.

Operation [Press button]	RCL07 LED display	Note
-----------------------------	-------------------	------

Programming CALL transmitters

CALL transmitters are used to trigger the CALL function.

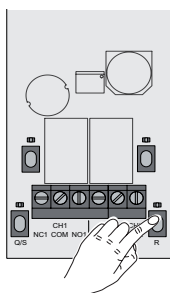

① R <1,6 s

1x R ON

2x R PULSE

3x R Operating mode

② Tx <1,6 s



① R <1,6 s LED R flashes slowly
(1x|pause|1x| ...)



Programming mode
OM ON selected

R <1,6 s LED R flashes in cycles of 2
(2x|pause|2x| ...)



Programming mode
OM PULSE selected

② Tx <1,6 s LED R lights up for 2 s

Transmission code programmed as CALL transmitter.

If the LED R flickers for 2 seconds during programming, the transmitter has already been programmed as a FUNCTION transmitter.

Programming PRIORITY transmitters

PRIORITY transmitters can trigger the CALL function, while the MUTE function is active.

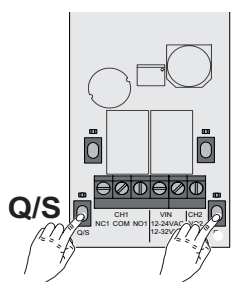

① R <1,6 s

1x R ON

2x R PULSE

3x R Operating mode

② Q/S <1,6 s



③ Tx <1,6 s

① R <1,6 s LED R flashes slowly
(1x|pause|1x| ...)



Programming mode
OM ON selected

R <1,6 s LED R flashes in cycles of 2
(2x|pause|2x| ...)



Programming mode
OM PULSE selected

② Q/S <1,6 s LED R and Q/S flash in the cycle of the selected OM

Programming mode
PRIORITY transmitter

③ Tx <1,6 s LED R lights up for 2 s

Transmission code programmed as PRIORITY transmitter

If the LED R flickers for 2 seconds during programming, the transmitter has already been programmed as a FUNCTION transmitter.

Programming FUNCTION transmitters

FUNCTION transmitters (de)activate the ACKNOWLEDGE, CARE or MUTE functions

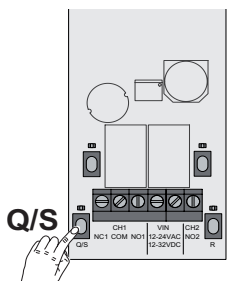

① Q/S <1,6 s

1x Q/S ACKNOWLEDGE transmitter

2x Q/S CARE transmitter

3x Q/S MUTE transmitter

4x Q/S Operating mode

② Tx <1,6 s

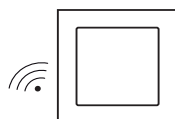

① Q/S <1,6 s LED Q/S flashes slowly
(1x|pause|1x| ...)



Programming mode
ACKNOWLEDGE transmitter

Q/S <1,6 s LED Q/S flashes in cycles of 2
(2x|pause|2x| ...)



Programming mode
CARE transmitter

Q/S <1,6 s LED Q/S flashes in cycles of 3
(3x|pause|3x| ...)



Programming mode
MUTE transmitter

② Tx <1,6 s LED Q/S lights up for 2 s





Transmission code programmed into the selected function

If the LED Q/S flickers for 2 seconds during programming, the transmitter has already been programmed as a CALL or PRIORITY transmitter.

Q/S Programming button Q/S
R Programming button R
Tx Transmitter button
OM Operating mode

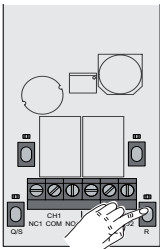
PROGRAMMING

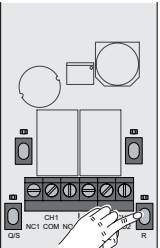
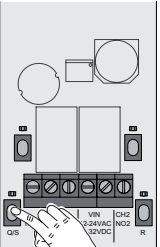
DELETING TRANSMITTERS

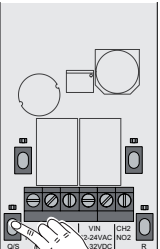
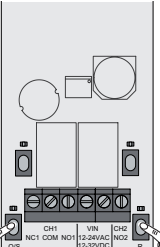
	Operation [Press button]	RCL07 LED display	Note
Deleting individual CALL / PRIORITY transmitters			
	① R >1,6 s	① R >1,6 s LED R flashes quickly	The receiver is ready for deleting CALL and PRIORITY transmitters for 30 seconds. To cancel, briefly press the R button 1x (<1.6 s).
	② Tx <1,6 s	② Tx <1,6 s LED R lights up for 2s	Press the transmitter button to be deleted. The transmission code is deleted and the RCL07 switches to operating mode.
 If you try to delete a FUNCTION transmitter in this mode, the LED R and LED Q/S flicker for 2 seconds. If you try to delete a transmitter that has not been programmed, the LED R flickers for 2 seconds.			
Deleting all CALL / PRIORITY transmitters			
	① R >1,6 s	① R >1,6 s LED R flashes quickly	The receiver is ready for deleting CALL and PRIORITY transmitters for 30 seconds. To cancel, briefly press the R button 1x (<1.6 s).
	② R >1,6 s	② R >1,6 s LED R lights up for 4s	All CALL and PRIORITY transmitters have been deleted and the RCL07 switches to operating mode.
Deleting individual FUNCTION transmitters			
	① Q/S >1,6 s	① Q/S >1,6 s LED Q/S flashes quickly	The receiver is ready for deleting FUNCTION transmitters for approx. 30 seconds. To cancel, briefly press the Q/S button 1x (<1.6 s).
	② Tx <1,6 s	② Tx <1,6 s LED Q/S lights up for 2s	Press the transmitter button to be deleted. The transmission code is deleted and the RCL07 switches to operating mode.
 If you try to delete a CALL or PRIORITY transmitter in this mode, the LED Q/S and the LED R flicker for 2 seconds. If you try to delete a transmitter that has not been programmed, the LED Q/S flickers for 2 seconds.			
Deleting all FUNCTION transmitters			
	① Q/S >1,6 s	① Q/S >1,6 s LED Q/S flashes very quickly	The receiver is ready for deleting all FUNCTION transmitters for approx. 30 seconds. To cancel, briefly press the Q/S button 1x (<1.6 s).
	② Q/S >1,6 s	② Q/S >1,6 s LED Q/S lights up for 4s	All FUNCTION transmitters have been deleted and the RCL07 switches to operating mode.
Deleting all transmitters (RESET)			
	① Q/S+R >1,6 s	① Q/S + R >1,6 s LED Q/S + R flashes very quickly	The receiver is in RESET standby for approx. 30 seconds. To cancel, briefly press the Q/S or R button 1x (<1.6 s).
	② Q/S+R >1,6 s	② Q/S + R >1,6 s LED Q/S + R light up for 4s	All transmitters have been deleted and the RCL07 switches to operating mode.

Q/S Programming button **Q/S**
R Programming button **R**
Tx Transmitter button

TRANSMITTER TYPES

All functions of the RCL07 (page 1 'Functions') can be switched using the buttons on the device as well as by radio. To be able to switch the various functions on and off by radio, an Easywave transmitter must be programmed into the RCL07 in the corresponding operating mode (page 2 'Programming').

The following transmitter types are available for programming:

CALL transmitters

- Trigger the CALL function on the RCL07. Relay CH1 is switched according to the selected operating mode and the red LED **Quit** lights up if the ACKNOWLEDGE function is activated.
- Do not trigger a CALL if the CARE function is active!
- Do not trigger a CALL if the MUTE function is active!
- Battery undervoltage is monitored if supported by the transmitter.
- A maximum of 32 CALL and PRIORITY transmitters can be programmed in total. The distribution is as required.

PRIORITY transmitters

- Trigger the CALL function on the RCL07, even if the MUTE function is active. The other behaviour corresponds to that of CALL transmitters.
- Do not trigger a CALL if the CARE function is active!
- Battery undervoltage is monitored if supported by the transmitter.
- A maximum of 32 CALL and PRIORITY transmitters can be programmed in total. The distribution is as required.

ACKNOWLEDGE transmitters

- Acknowledge pending calls on the RCL07.
- Switch off the red LED **Quit** when a CALL is pending and the ACKNOWLEDGEMENT function is active.
- Resets the relay CH1 when a CALL is pending (even when the ACKNOWLEDGEMENT function is deactivated).
- No monitoring of battery undervoltage.
- A maximum of 8 ACKNOWLEDGE transmitters can be programmed.

CARE transmitters

- Switch on the CARE function by briefly pressing transmitter button B or D for a maximum of 15 minutes.
- Can switch off the CARE function manually before the 15 minutes have elapsed by briefly pressing transmitter button A or C.
- The green LED flashes when the CARE function is active.
- Also possible while the MUTE function is active.
- No monitoring of battery undervoltage.
- A maximum of 8 CARE transmitters can be programmed.

MUTE transmitters

- Mute the RCL07 for an unlimited period of time by briefly pressing transmitter button B or D.
- Briefly pressing transmitter button A or C unmutes the RCL07 again.
- If the RCL07 is muted via the MUTE function, it will only respond to calls from PRIORITY transmitters. Calls from CALL transmitters are ignored in this mode. The green LED is off in this state, but flashes if the CARE function is active.
- Prerequisite: MUTE function activated on jumper J1.
- No monitoring of the battery undervoltage.
- A maximum of 8 MUTE transmitters can be programmed.

BATTERY UNDERVOLTAGE

If the battery capacity of a programmed CALL or PRIORITY transmitter with battery control function is low, the transmitter sends an undervoltage data telegram. The relay channel 2 (CH2) is switched for approx. one second and the red LED  flashes to signal the undervoltage.

If the RCL07 receives an undervoltage data telegram while the ACKNOWLEDGE function is active, the undervoltage is only displayed on the device after a possible call has been acknowledged. Now change the battery of the last call transmitter used. If the RCL07 receives two telegrams in succession from this transmitter without an undervoltage data message, the receiver resets the undervoltage display automatically.

The undervoltage display can also be reset by briefly pressing the **Quit** button.

If a call and an undervoltage telegram are received at the same time, the call has to be acknowledged first.

GENERAL INFORMATION

Waste electrical products are not to be disposed of with household waste!

Dispose of the waste product via a collection point for electronic scrap or via your specialist dealer.



Put the packaging material into the recycling bins for cardboard, paper and plastics.



Warranty

Within the statutory warranty period, we undertake to rectify free of charge by repair or replacement any product defects arising from material or production faults.

Any unauthorized tampering with or modifications to the product shall render this warranty null and void.

Conformity



ELDAT EaS GmbH hereby declares that the radio equipment type RCL07 is in compliance with Directive 2014/53/EU. The full text of the EU declaration of conformity is available at the following internet address: www.eldat.de

Customer Service

If the device does not work properly despite proper handling or in case of damage, please contact the manufacturer or your retailer.

ELDAT EaS GmbH

Schmiedestraße 2
15745 Wildau
Germany

Phone: +49 3375 9037-310

Internet: www.eldat.de

Email: info@eldat.de